

Standard & High Temperature Open Frame DIP Sockets

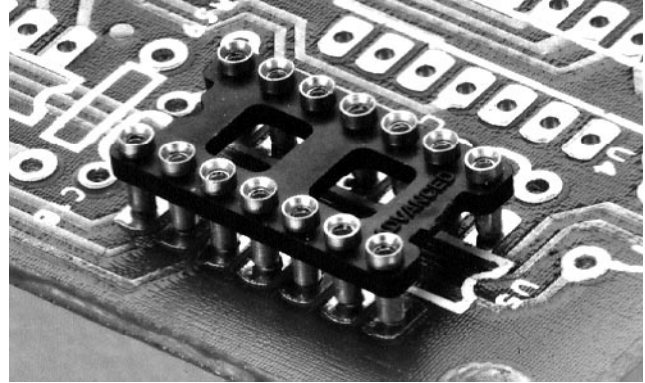
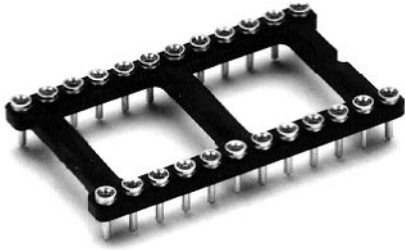

Features:

- Multiple finger contact on all sockets assures maximum reliability.
- Tapered entry for ease of insertion.
- Closed bottom sleeve for 100% anti-wicking of solder.
- To fit .100" (2.54 mm) pitch.
- Easily customized to fit your application.
- For surface mount applications use HLS only.

Terminals and Contacts:

Terminal: Brass - Copper Alloy (C36000)
ASTM-B-16

Contact: Beryllium Copper - Copper Alloy
(C17200) ASTM-B-194

Solder Preform:

63% Tin, 37% Lead

Plating:

Terminal: Gold over Nickel or
Tin-Lead over Nickel

Contact: Gold over Nickel or
Tin-Lead over Nickel

Gold per MIL-G-45204

Tin-Lead per MIL-P-81728

Nickel per QQ-N-290

Standard Sockets

LS - Insulator Material:

Glass Filled Thermoplastic Polyester (P.B.T.)

U.L. Rated 94V-O, -60°C to 140°C (-76°F to 284°F)

How To Order

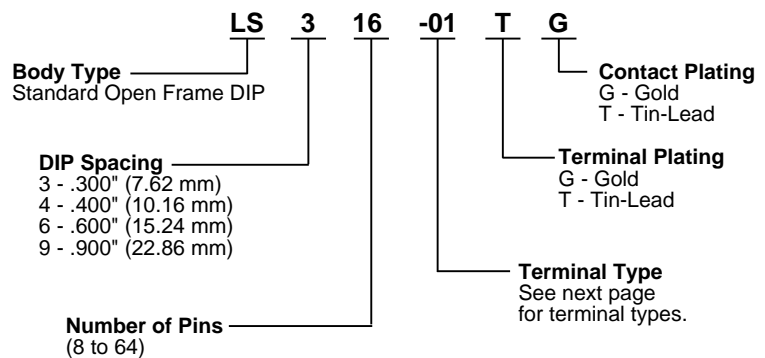

High Temperature Sockets

HLS - Insulator Material:

High Temp. Glass Filled Thermoplastic

U.L. Rated 94V-O, -60°C to 260°C (-76°F to 500°F)

How To Order

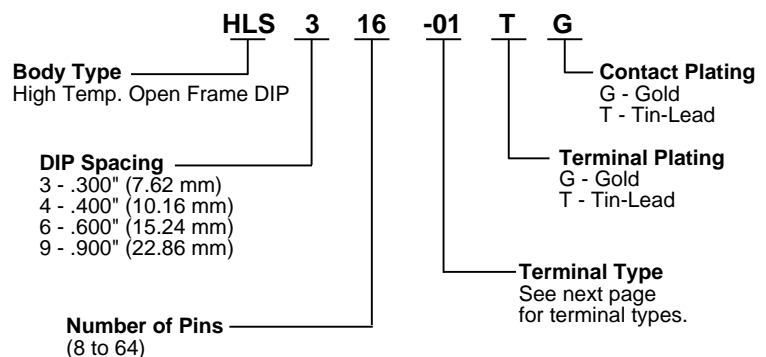

Standard & High Temperature Open Frame DIP Sockets

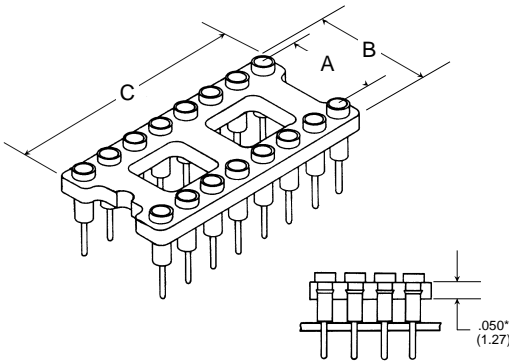

Dimensional Information

# of Pins	A	B	C
8	.300 (7.62)	.400 (10.16)	.400 (10.16)
14	.300 (7.62)	.400 (10.16)	.700 (17.78)
16	.300 (7.62)	.400 (10.16)	.800 (20.32)
18	.300 (7.62)	.400 (10.16)	.900 (22.86)
20	.300 (7.62)	.400 (10.16)	1.000 (25.40)
22	.300 (7.62)	.400 (10.16)	1.100 (27.94)
24	.300 (7.62)	.400 (10.16)	1.200 (30.48)
28	.300 (7.62)	.400 (10.16)	1.400 (35.56)
22	.400 (10.16)	.500 (12.70)	1.100 (27.54)
24	.400 (10.16)	.500 (12.70)	1.200 (30.48)
24	.600 (15.24)	.700 (17.78)	1.200 (30.48)
28	.600 (15.24)	.700 (17.78)	1.400 (35.56)
32	.600 (15.24)	.700 (17.78)	1.600 (40.64)
40	.600 (15.24)	.700 (17.78)	2.000 (50.80)
48*	.600 (15.24)	.700 (17.78)	2.400 (60.96)
64*	.900 (22.86)	1.000 (25.40)	3.200 (81.28)

*Socket body thickness is .100/(2.54)
for 48 and 64 positions

Terminal Information

Low Profile Solder Tail
Type -01

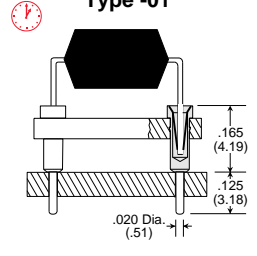

Low Profile Solder Tail
Type -29

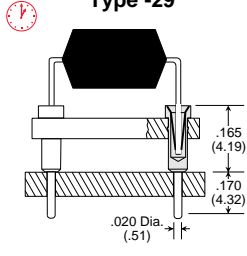

Low Profile Solder Tail
Type -30

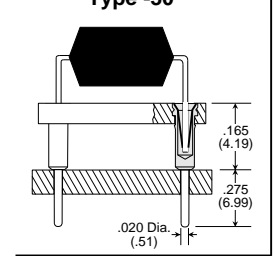

Low Profile Solder Tail
Type -51

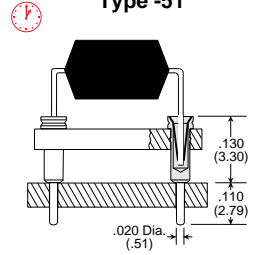

Super Low Profile
Type -04

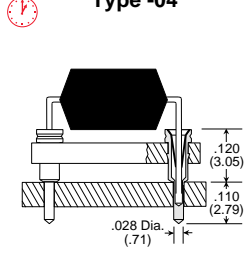

Super Low Profile
Type -38

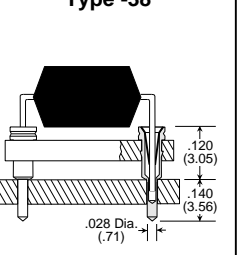

Ultra Low Profile
Type -49

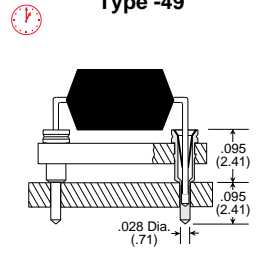

Ultra Low Profile
Type -299

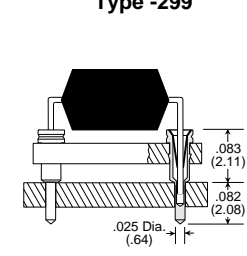

Surface Mount
Type -237
HLS Only

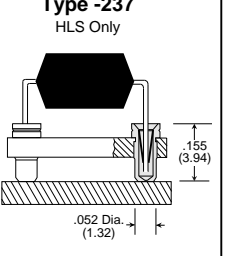

Quick turn delivery available on standard terminal types.

Additional terminal types available.
See terminal section for detailed terminal information.

Solder Preform Terminals Available on HLS Body Type

Type -150

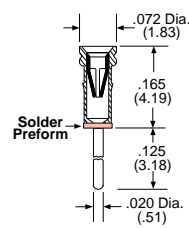

Type -151

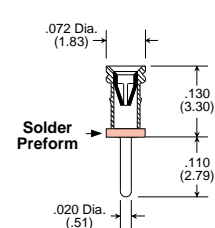

See page 81 for complete details.

SEARCH BY KEYWORD

1. Enter any word or words that describe what your are looking for.
2. Select Search by: Keyword.
3. Click the SEARCH button.

You will be presented with a list of products that match your criteria. Click on the product name to get technical specs and access product-specific features such as Data Sheets in PDF format, our Build-A-Part online product configurator, Related Documents and more.

SEARCH BY PART NUMBER

For a quick product description and link to the product family page:

1. Enter an exact part number (not case sensitive, but dashes must be included in the proper place, ex. MGSB357-636GG or 1KS068-85TG).
2. Select Search by: Part Number.
3. Click the SEARCH button.

SEARCH FOR A DISTRIBUTOR OR REPRESENTATIVE

To find a local Distributor or Representative, please click on [Global Sales Directory](#).

SEARCH BY PART NUMBER

4-digit part numbers for custom products and terminal part numbers are not included in the database. Please contact [customer service](#) with your name and company contact information for product information and CAD drawings for any products not listed.

For detailed product information (data sheet, etc.), click on the Product Family link and use the description below to select the product-specific category from the next screen. To check if a CAD Drawing is available on-line, use the CAD Drawing Lookup link in the bar at the bottom of the page.

Product Family	Part No.	Description
DIP Sockets & Adapters	LS324-48TG	24 POS. MOLDED DIP SOCKET